

PowerLux® 16" LED HighBay

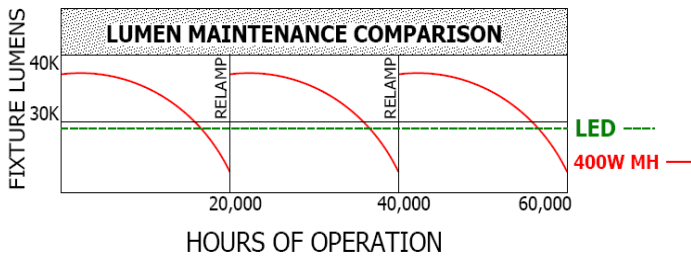

FIXTURE DIMENSIONS:

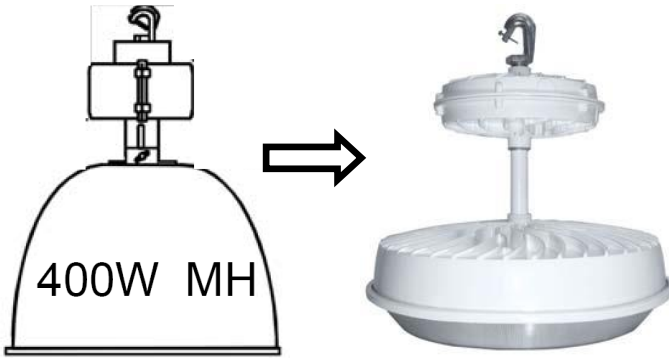
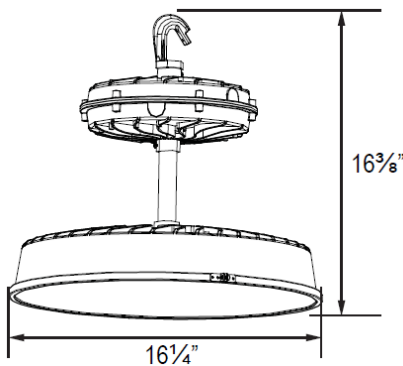

Note: Also available in 22"

ORDERING INFORMATION:

Model No.	Wattage	CCT	Lens	Input Voltage	Additional Options (factory installed)	Dimmable Motion Sensor
PLEDHB1616	169W	4K=4000K 5K=5000K	CG=Clear Flat Glass CP=Clear Flat Prismatic Glass AC=Acrylic Conical Lens AD=Acrylic Drop Lens PD= Polycarbonate Drop Lens	U=120-277V UH=347/480V	SF=Single Fuse DF=Double Fuse SP=Surge Protector WG= Wire Guard SC= Steel Safety Chain Note: For Plugs and Cords options, see chart below	DMS= Dimmable Motion Sensor DMSP= Dimmable Motion Sensor with Photocell

Part Number Example: PLEDHB1616/169/4K/CP/U/SP/DMS

Description: PowerLux® 16" LED HighBay Luminaire 169W, 4000 Kelvin, Clear Flat Prismatic Glass (18,019 Lumens), 120-277V, Surge Protector, Dimmable Motion Sensor

Catalog#		Type
Project		
Note		Date
Prepared by		

APPLICATIONS

For gymnasiums, large retail stores, sport arenas, factories, warehouses, or for general illumination. Designed to replace HID lighting systems up to 400W MH. Suitable for 16 to 30 foot mounting heights based on light level.

HOUSING FEATURES:

- Die cast aluminum housing with external heat sinks for cooler operating temperatures
- Powdercoat finish over a chromatic conversion coating. Includes 4" stem. Max stem length: 30 feet
- Mount with included 1" malleable hook

LENS:

Tempered Flat Clear or Prismatic Glass, Polycarbonate Drop Lens, Acrylic Drop Lens or Acrylic Conical Lens

LED ARRAY FEATURES:

- CRI: 80
- CCT: 4000K, 5000K
- **Delivered lumens:**
Clear Glass: 4000K=19,019; 5000K=19,811
Prismatic Glass: 4000K= 18,019; 5000K=19,611
Conical Lens: 4000K= 17,456; 5000K=18,184
Drop Lens: 4000K= 15,784; 5000K=16,442
- 5-Year warranty

SYSTEM WATTAGE:

- Array 169W, System 178.5W

LED DRIVER:

- Instant ON and instant re-strike with back-to-full brightness
- Voltage Input: 120-277V, 50/60Hz OR 347/480V, 50/60Hz

BI-LEVEL DIMMABLE MOTION SENSOR:

- Optional. Can be easily added to the fixture

Listing & Rating

- CSA: Listed for damp locations (lens gasket required) IP54
- Operating temperatures: -40°C to +50°C
- DLC Listed as: **HB44QF1X169U5KG**
- Calculated L70 @25°C=302,000 Hours

Assembled in the USA

PowerLux® Corporation

U.S. Manufacturer of Sustainable Energy Efficient Lighting Products

1260 Liberty Way, Suite E Vista, CA 92081 Phone: 760-727-2360 Fax: 760-434-4766

Website: www.powerlux.com E-mail: klpowerlux@gmail.com

PowerLux® Products Have Stood the Test of Time!

Based on prevailing model. Efficiency of the LED driver and efficacy of LED modules are ever improving. Please contact [PowerLux®](http://www.PowerLux.com) for latest updated information.

170815
Patents pending
Specifications subject to change without prior notice
© 2014-2017 by PowerLux® Corporation. All rights reserved

Catalog#		Type
Project		
Note		Date
Prepared by		

PHOTOMETRICS:

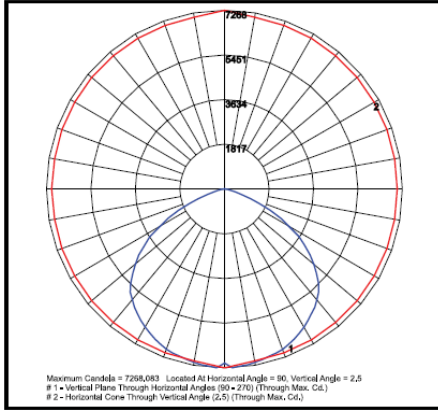

169W with Clear Flat Glass Lens and 5000K CCT

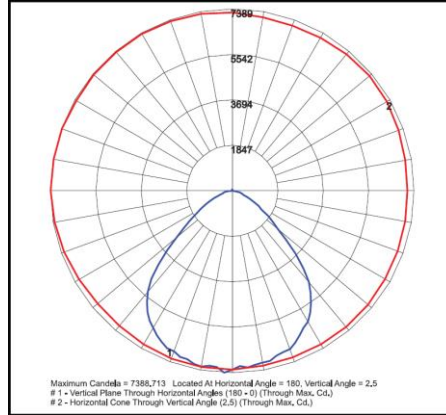

169W with Clear Flat Prismatic Glass Lens and 5000K CCT

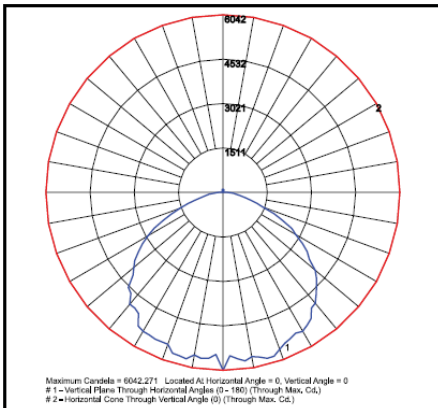

169W with Acrylic Conical Lens and 5000K CCT

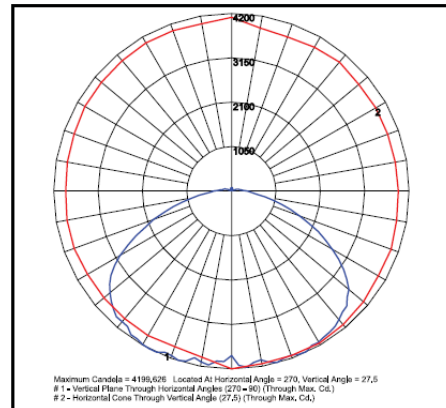

169W with Acrylic Drop Lens and 5000K CCT

Plugs and Cords:

C6 =6ft. white cord, 300VAC, 3 wire, Leads	L5 =6ft. white cord, 3 wire, L5-15P Twist-Lock Plug	L7 =6ft. white cord, 3 wire, L7-15P Twist-Lock Plug	C66 =6ft. black cord, type STW, 600VAC, 3 wire, leads

Accessories

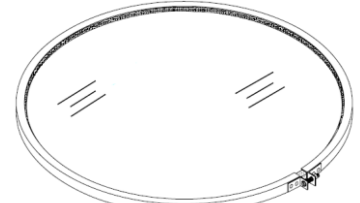

CG= Clear Flat Glass
CP=Clear Flat Prismatic Glass (both with gasket)



AC=Acrylic Conical Lens



PD=Polycarbonate Drop Lens
AD=Acrylic Drop Lens

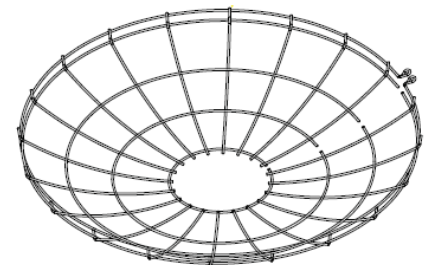

WG=Wire Guard
(For use with Flat Glass Lenses)



CB=Clamp Band
(Used with Conical or Drop Lenses)

PowerLux® Corporation

U.S. Manufacturer of Sustainable Energy Efficient Lighting Products

1260 Liberty Way, Suite E Vista, CA 92081 Phone: 760-727-2360 Fax: 760-434-4766

Website: www.powerlux.com E-mail: klpowerlux@gmail.com

PowerLux® Products Have Stood the Test of Time!

Based on prevailing model. Efficiency of the LED driver and efficacy of LED modules are ever improving. Please contact PowerLux.com for latest updated information.

170815
 Patents pending
 Specifications subject to change without prior notice
 © 2014-2017 by PowerLux® Corporation. All rights reserved

PowerLux® 16" LED HighBay

Bi-Level Dimmable Motion Sensor



Catalog#		Type
Project		
Note		Date
Prepared by		

Bi-Level Dimmable Motion Sensor Features:

- Use for Controlling PowerLux HighBays in commercial, warehouse, retail, schools, and industrial applications
- Detection Range: 360°, Up to 48 Feet
- Time Delay: 5s, 30s, 90s, 3min, 20min, & 30min
- Detection Motion Speed: 2 to 10 Feet per second
- Installation Height: 10' to 48'
- Detection Zone: 52 feet diameter x 48 Feet High
- Daylight Sensor: 3 light level settings for daylight harvesting
- Vacant to Dim Settings: 10%, 20%, 30%, 50%
- Vacant Stand-by Delay: 5s, 5min, 10min, 30min, & 60min

- Ambient Temp: -35°C to 70°C
- Relative Humidity: <93%
- Power Consumption: 1.5w (Static 0.8w)
- Load Rating:
 - 400w (120VAC), 800w (277VAC) - Inductive Load
 - 800w (120VAC), 1200w (277VAC) - Resistive Load
- Housing: IP65
- Cord: 30" 5-Wire white cord with Liquid-Tight connector at sensor housing

Program Settings:

- Detection Area (50%, 100%)
- Hold Time (Vacant Off Delay)
- Standby Period (Time for Low Level Before Off After Vacant Delay)
- Standby Dimming (Level Selection for Low Level Before Off)
- Daylight Sensor (Daylight Harvesting)

PowerLux® Corporation

U.S. Manufacturer of Sustainable Energy Efficient Lighting Products

1260 Liberty Way, Suite E Vista, CA 92081 Phone: 760-727-2360 Fax: 760-434-4766

Website: www.powerlux.com E-mail: klpowerlux@gmail.com

PowerLux® Products Have Stood the Test of Time!

Based on prevailing model. Efficiency of the LED driver and efficacy of LED modules are ever improving. Please contact [PowerLux®](http://www.powerlux.com) for latest updated information.

170815
Patents pending
Specifications subject to change without prior notice
© 2014-2017 by PowerLux® Corporation. All rights reserved